

Earth-Rite® PLUS™

Static Grounding Indicator and Interlock System



Precision and reliability is what the **Earth-Rite® PLUS™** provides to QHSE professionals and engineers who are tasked with protecting personnel and plant assets from the ignition hazards of static electricity during railcar, skid, and IBC loading/unloading operations.

Enquiry > Click here to submit a product related query or a request for quotation.

Conductive metal objects like railcars, LACT units, skids and IBCs that come into contact with electrostatically charged liquids can accumulate hazardous levels of electrostatic charge that could discharge static sparks with energies far in excess of the minimum ignition energies of a vast range of combustible gases and vapours. The ignition of combustible atmospheres by static electricity can be prevented by ensuring that such objects are grounded.

The **Earth-Rite PLUS** is the ideal solution for grounding and bonding a broad range of equipment at risk of igniting combustible gases and vapours. The **Earth-Rite PLUS** ensures that a continuously

monitored 10 ohm, or less, connection is present between the grounded object and a designated true earth grounding point. This feature provides equipment specifiers with the ability to demonstrate compliance with the grounding and bonding recommendations of IEC 60079-32*, NFPA 77* and API RP 2003*.

***IEC 60079-32**, "Explosive atmospheres: electrostatic hazards, guidance."

***NFPA 77**, "Recommended Practice on Static Electricity."

***API RP 2003**, "Protection Against Ignitions Arising Out of Static, Lightning, and Stray Currents."



Earth-Rite PLUS Static Grounding System

The Earth-Rite PLUS includes:

- > **Ex(d) / XP Controller** with Intrinsically Safe Monitoring Circuit.
- > **Ground Connection Junction Box** with Clamp Stowage Point and Quick Release Connector.
- > **Junction Box with Stowage Pin** for stowing Universal Grounding Clamp.

Earth-Rite® PLUS™ Static Grounding Indicator and Interlock System

Features and Benefits

Attention grabbing LEDs

Three green LEDs continuously pulse informing operators that the object to be protected from static discharges is grounded. When the system is not in use, or when it detects the resistance in the static grounding path is higher than 10 ohms*, a red LED illuminates the indicator panel located inside the enclosure.

Continuous Ground Loop Monitoring

Monitors the resistance of the ground loop from the grounded object through to the site's verified true earth grounding point. If the Earth-Rite® PLUS detects that resistance in the ground loop is higher than 10 ohms, it engages a pair of volt free changeover contacts that can be interlocked with the product transfer system.

Two volt free output contacts

The primary contact can be interlocked with electro-mechanical devices or PLC systems to shut down the flow of product. The secondary contact can interface with attention grabbing audible alarms or strobe lights to provide an extra layer of protection over the hazard.

Easy Installation

Simple "bolt-on" enclosures complemented by straightforward cabling and PCB system wiring requirements. Flexible EX enclosure options and power supplies which can run off both 240 V / 110 V AC and 24 V / 12V DC.

* The international recommended practice for controlling the ignition hazards of static electricity in EX atmospheres, IEC 60079-32 and NFPA 77, recommend that the maximum resistance between conductive metal plant equipment and verified true earth grounding points should not be more than 10 ohms resistance.



Universal grounding clamp
with Quick Connect and optional lengths of Hytrel protected 2 core cable included.



Pulsing LEDs confirm positive ground condition

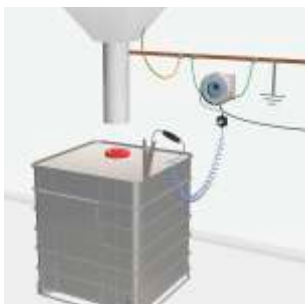

Filling IBCs, Totes, Drums, Containers and Rail Cars







The Earth-Rite® PLUS™ forms part of the Earth-Rite® range of Static Grounding and Bonding Equipment available from Newson Gale Ltd.

Options

- 15m Self-Retracting Cable Reel
- 5, 10, 15 mtr lengths of Retractable Spiral Cable
- Explosion Proof Strobe Light
- IEC/Cenelec (European) and NEC/CEC (North American) versions available

Certification

Ingress Protection
IP 66

Temperature Range
-40°C to +55°C - ATEX /
IECEX
-13°F to +122°F - CSA

Power Supply
110/120V or 220/240V AC, 50-60 Hz
12V or 24V DC

Earth-Rite® PLUS™ Static Grounding Indicator and Interlock System

Technical Specification

Ex d (Zone 1 Gas / Vapour Installations - Zone 21 Dust Atmospheres)

Monitoring Unit	
Power Supply	110/120 V or 220/240 V AC, 50-60 Hz 12 V or 24 V DC
Power Rating	10 watt
Ambient Temperature Range	-40°C to +55°C
Ingress Protection	IP 66
Weight	4.5 kgs (9.9 lbs) nett
Construction	Copper-free cast aluminium
Monitoring Circuit	Intrinsically safe
Operational Series Ground Resistance	Nominally ≤ 10 Ohm
Output Relay Contact Rating	2 off voltage free change-over switch contacts, 250 V AC, 5 A, 500 VA max resistive 30 V DC, 2 A, 60 W max resistive
Cable Entries	7 x M20 (2 x plugged)
Junction Box/Stowage Point	
Enclosure Material	GRP with carbon loading
Terminals	2 x 2.5 mm ² conductor capacity
Stowage Device	Insulated 20 mm Ø pin
Cable Entries	1 x 20 mm
Clamp Cable Connection	Quick Connect
Grounding Clamp	
Clamp Design	2 pole with tungsten carbide teeth
Body	Stainless steel
Certification	Ex II 1 GD T6
Approval	FM Approved
Spiral Cable	
Cable	Blue Cen-Stat Hytrei sheath (Static dissipative, chemical & abrasion resistant)
Conductors	2 x 1.00 mm ² copper
Length	10 metres extended, 1 metre unextended (other lengths available, please enquire)

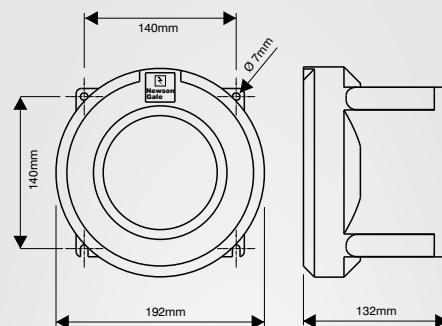

Copper free cast aluminium enclosure - IP 66

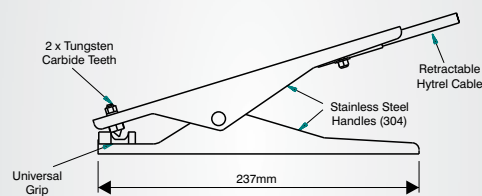

ATEX certified / FM Approved 2 Pole stainless steel grounding clamp fitted with one pair of tungsten carbide tips

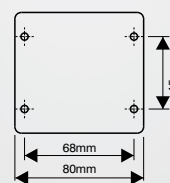
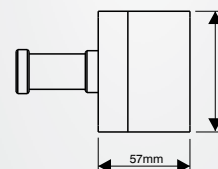

Simple Apparatus GRP clamp stowage box with grounding clamp stowage pin

Earth-Rite® PLUS™ Static Grounding Indicator and Interlock System

Hazardous Area Certification

Europe / International:

IECEX

Ex d[ia] IIC T6 Gb(Ga) (gas & vapour).
Ex tb IIIC T80°C IP66 Db (combustible dusts).
Ta = -40°C to +55°C.
IECEX SIR 09.0018
IECEX certifying body: SIRA.

ATEX

Ⓜ II 2(1)GD
Ex d[ia] IIC T6 Gb(Ga)
Ex tb IIIC T80°C IP66 Db
Ta = -40°C to +55°C.
Sira 09ATEX2047
ATEX Notified Body: SIRA.

North America:

NEC 500 / CEC (Class & Division)

Associated Equipment [Ex ia] for use in
Class I, Div. 1, Groups A, B, C, D;
Class II, Div. 1, Groups E, F, G;
Class III, Div. 1,
Providing intrinsically safe circuits for
Class I, Div. 1, Groups A, B, C, D;
Class II, Div. 1, Groups E, F, G;
Class III, Div. 1,
When installed per Control Dwg;
ERII-Q-10110 cCSAus
Ta = -40°C to +50°C.
Ta = -40°F to +122°F.

OSHA recognised NRTL: CSA.

NEC 505 & 506 (Class & Zoning)

Class I, Zone 1 [0] AEx d[ia] IIC T6 Gb(Ga)
(gas & vapour).
Class II, Zone 21 [20] AEx tD [iaD] 21 T80°C
(combustible dusts).

CEC Section 18 (Class & Zoning)

Class I, Zone 1[0] Ex d[ia] IIC T6 Gb(Ga)
DIP A21, IP66, T80°C

Additional Certification

Safety Integrity Level:

SIL 2 (in accordance with IEC/EN 61508).

SIL assessment body:

Exida

EMC Tested:

to EN 61000-6-4, EN 61000-6-2
FCC - Part 15 (Class B)



Earth-Rite® PLUS™ Static Grounding Indicator and Interlock System

System options

Newson Gale supplies a range of product options that enhance the control and general safety of transfer processes and aid engineers with system installations and routine system service checks. Contact Newson Gale or your local Newson Gale representative for more information on the range of options available.

VESM02 Retractable Cable Reel

The VESM02 Retractable Cable Reel is supplied for grounding system installations where customers want to ensure the grounding clamp and cable are returned to the static grounding system by operators and drivers on completion of the product transfer process. The **VESM02 Reel** can be used in conjunction with the **Earth-Rite RTR**, **Earth-Rite MGV** and **Earth-Rite PLUS**.

- > Certified for ATEX Zone 1 and 21 hazardous areas.
- > Self-retracting with up to 15 m (50 ft.) of Hytrel® protected cable.
- > Silver plated ultra low resistance slip ring contacts.
- > ATEX -  II 2 GD T6



VESM02 Retractable Cable Reel

Product Code: VESM02.

Ex Strobe Light

The strobe light is mounted in an elevated position and when the equipment is correctly grounded, flashes continuously informing personnel that a transfer process is underway and is protected from the static hazard. The strobe light can be used in conjunction with the **Earth-Rite RTR** and **Earth-Rite PLUS**.

- > 115 V / 230 V AC and 24 V DC options.
- > ATEX /IECEx approved Exd strobe light.
- >  II 2 Ex d IIC T4 (Ta. -50°C to +70°C).
- > II 2G Ex d IIC T5 (Ta. -50°C to +40°C).
- > II 2D Ex tD A21 IP67 T125°C based on max. Ta. 70°C.



Ex Strobe Light

Product Code: STROBE11/A
(Amber strobe). Please enquire for options.

Sun Shield

Designed for operating environments subject to intense sunlight, the ERII Sun Shield prevents direct sunlight hitting the indicators on the **Earth-Rite RTR** and **Earth-Rite PLUS** static grounding systems.

The Sun Shield casts a shadow over the indicators during peak sun light hours so that operators can easily view the ground status indicators. The shield is constructed from stainless steel and can be fitted to any installation in a matter of minutes.



Sun Shield

Product Code: ER2/SH

Earth-Rite® PLUS™ Static Grounding Indicator and Interlock System

Universal Resistance Tester

The URT is designed to provide owners of Newson Gale **Earth-Rite®** and **Bond-Rite®** static grounding systems with a means of regularly testing the grounding settings for their system on a routine basis.

Periodic testing with the URT verifies that the grounding system's **GO/NO GO** settings are working in compliance with the recommendations of:

NFPA 77: "Recommended Practice on Static Electricity."

IEC 60079-32-1: "Explosive atmospheres. Part 32-1: Electrostatic hazards, guidance."

The easy to use tester consists of a pair of switches that enable an electrician to set up the resistance level at which the grounding system should be working and conduct a **PASS / FAIL** test at the required setting.

Earth-Rite® and **Bond-Rite®** products that can be tested with the URT:

- > Earth-Rite® PLUS
- > Earth-Rite® FIBC (both 10 meg-ohm and 100 meg-ohm variants)
- > Bond-Rite® CLAMP
- > Bond-Rite® EZ
- > Bond-Rite® REMOTE
- > OhmGuard® (both 10 ohm and 100 ohm variants).

Installer's Kit

This kit provides installation engineers with the necessary Ex (d) enclosure glands (x5) and system cable (x3) required to complete an **Earth-Rite RTR** or **Earth-Rite PLUS** installation as specified in the system installation manuals. Two of the glands cater for both armoured and non-armoured cable diameters ranging from 9 mm to 13.5 mm. Three glands cater for IS current carrying non-armoured cable with cable diameters ranging from 4 mm to 8.4 mm. * For areas not requiring IIC apparatus.

- > Ex (d) IP68 glands (x2) for armoured cable 9 mm to 13.5 mm Ø.*
- > Ex (d) IP68 glands (x3) for non-armoured cable 4 mm to 8.4 mm Ø.*
- > 3 m of 2 core conductor cable (x1) to connect system enclosure to clamp storage box.
- > 1 m of solid green earth loop cable (x2), with Ex (d) glands, PCB connectors and 10 mm bolt eyelets attached.
- > 1 pair of handles to aid opening and closing of the enclosure lid.



Universal Resistance Tester
Product Code: URT.



Installer's Kit
Product Code: ER2KITA
(Power cable and interlock cable not supplied).

Earth-Rite® PLUS™ Static Grounding Indicator and Interlock System



Product Ordering Codes * Additional Options Available

Ordering Code	Product Description
PLUSMEA1A3*	Earth-Rite PLUS™ Static Grounding Unit - ATEX IIC, 220/240 V AC \pm 10% including Heavy Duty grounding clamp, 10 m retractable spiral cable and GRP clamp stowage box.
STROBE11/A (230V AC)	Amber Strobe, 15 J, 115 V / 230 V AC and 24 V DC options. Please enquire for further options.
ER2KITA (IIA / IIB atmospheres)	Installer's Kit including Ex(d) armoured glands for non-IS cable (x2 off), Ex(d) non-armoured glands (x3 off) for IS cabling, junction box cable (3 m x 1 off), static grounding cables (1 m x 2 off) and enclosure lid handles.
VESM02	VESM02 Retractable Cable reel with 15 m (50 ft.) of 2 conductor Hytrel protected static grounding cable
ER2/SH	Earth-Rite Sun Shield
URT	Universal Resistance Tester

Contact Us > Your enquiry will be processed rapidly via our webform enquiry service. If you would prefer to call us, or e-mail us, please use the contact details provided below.

* Alternative clamp, cable length and reel options upon request.
Contact your local sales office or distributor with your requirements.