

NØDLYSARMATUR

ONTEC C - C1

- Asymmetrisk innfelt armatur for belysning av korridorer.
- Passer for normal takhøyde mellom 2,5 – 6m.
- Innfelt.



Art. nr	Navn	Drift	Batteri type / tid	Selvtest	Adresserbar
781774	Ontec C C1 AT Asym	Batteriarmlatur	LiFePO4/C 3,2V 1,5Ah / 1 time	Ja	Nei
781776	Ontec C C1 DATA2 Asym	Batteriarmlatur	LiFePO4/C 3,2V 1,5Ah / 1 time	Ja	Ja
781777	Ontec C C1 CB Asym	Sentral	Ifølge sentral	Nei	Nei
781775	Ontec C C1 CBA Overvåket Asym	Sentral	Ifølge sentral	Nei	Ja

MÅL

Mål i mm

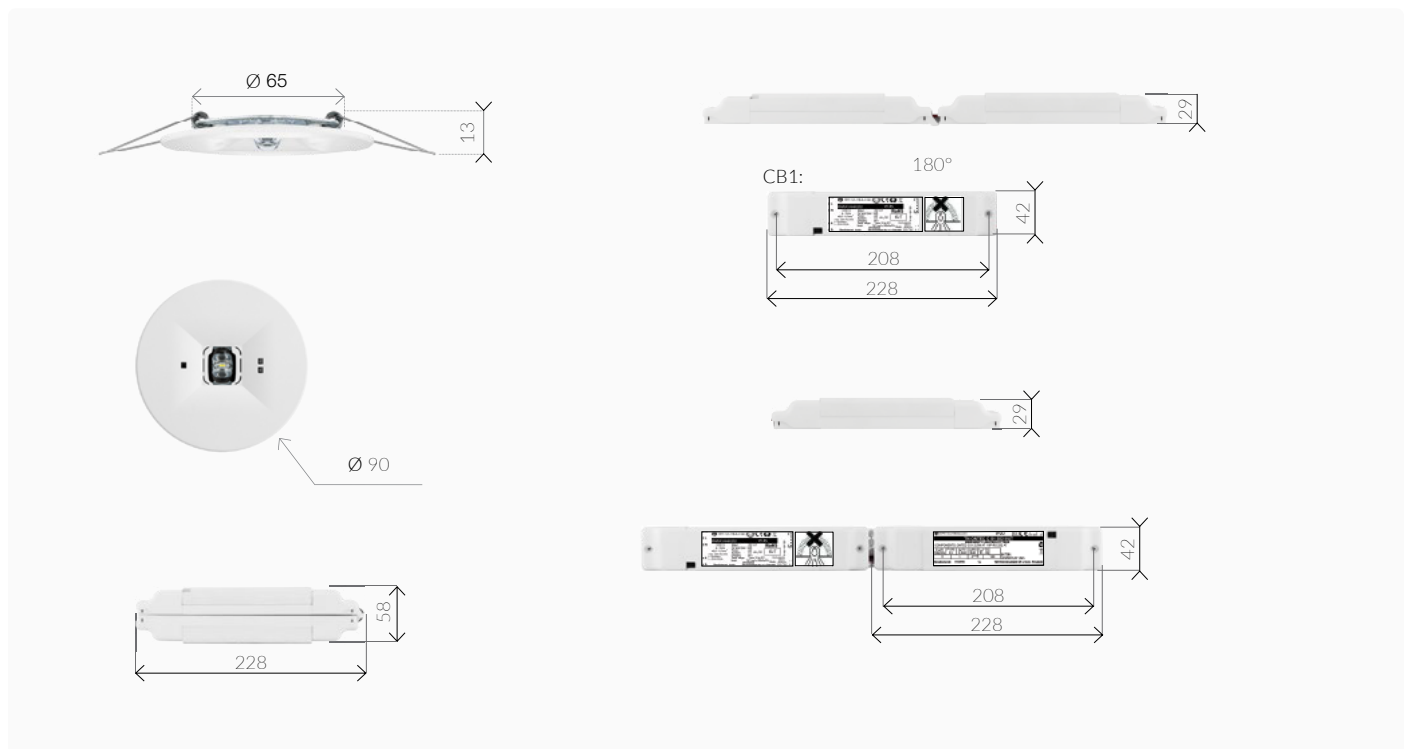

TEKNISKE DATA

	Sentral	Desentralisert
Luminans	296 lm	296 lm
Innkobling	Permanent lys / Beredskaps lys	Beredskaps lys
IP-klasse	IP20	IP20
Beskyttelsesklasse	II	II
IK-klasse	IK03	IK03
Farge	Hvit RAL9003. Annen (RAL) farge på forespørsel	Hvit RAL9003. Annen (RAL) farge på forespørsel
Materiale	Polykarbonat	Polykarbonat
Montering	Innfelt	Innfelt
Tilkoblings klemme	Skiftbar 2 x 2,5 mm ²	Skiftbar 2 x 2,5 mm ²
Driftsspenning (V)	210 – 250V AC, 50 – 60Hz / 186 – 254V DC	210 – 250V AC, 50 – 60Hz
Total effekt	CB 4,5W / CBA 5,5W	1,2W
Tillatt omgivelsestemperatur	CB -15°C til +55°C / CBA -10°C til +40°C	+10°C til +35°C





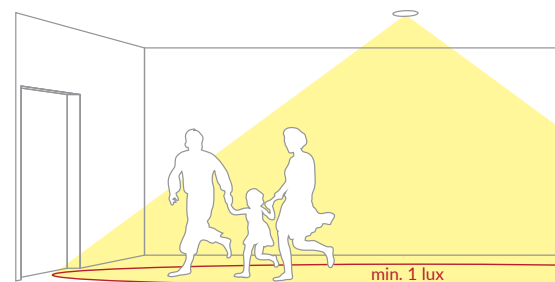
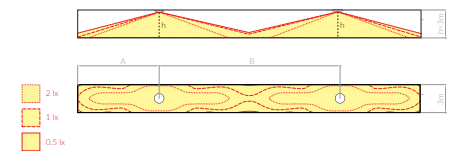
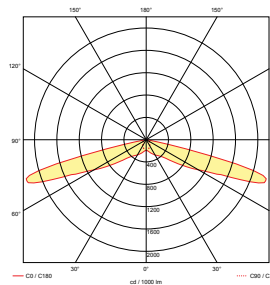

PROSJEKTERINGSGUIDE

E = 1 Lux Målhøyde: 0,02 m, vedlikeholds faktor MF = 0,8

[m]	A	B
2,5	8,6	19,2
3,0	9,6	22,1
4,0	10,3	26,4
5,0	7	28
6,0	3,2	23



SERTIFIKAT

	PN-EN 60598-1	PN-EN 61000-3-2
	PN-EN 60598-2-22	PN-EN 62031
	PN-EN 61347-1	PN-EN 62471
	PN-EN 61347-2-7	PN-EN 1838
	PN-EN 61347-2-13	
	PN-EN 55015	

EMBALLASJE

Mål i mm

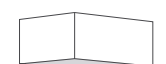
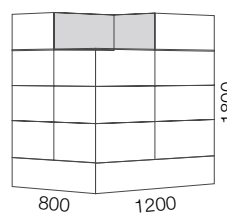

330 x 950 x 40

800st